

# VINYL-BACK COLLECTOR HEADS



525 Morley Drive  
Saginaw, MI 48601  
Ph: 1 (800) 248-0280  
Fx: 1 (800) 432-9331



831 Morley Drive  
Saginaw, MI 48601  
Ph: 1 (800) 248-0280  
Fx: 1 (989) 753-7073

Date: \_\_\_\_\_

Status:  Quote  Order

Ordered By: \_\_\_\_\_ Acct. # \_\_\_\_\_

Job Name: \_\_\_\_\_

Contractor: \_\_\_\_\_

Address: \_\_\_\_\_

Address: \_\_\_\_\_

City: \_\_\_\_\_ St \_\_\_\_\_ Zip \_\_\_\_\_

City: \_\_\_\_\_ St \_\_\_\_\_ Zip \_\_\_\_\_

P.O. # : \_\_\_\_\_ Job # : \_\_\_\_\_

Phone #: \_\_\_\_\_ Fax: \_\_\_\_\_

Original Order # : \_\_\_\_\_

Special Instructions: \_\_\_\_\_

Membrane Thickness: \_\_\_\_\_

Ship Via: \_\_\_\_\_

Ship To:  Contractor Location  Jobsite

Other (provide address below)

**Note: 1/4" must be subtracted from height and width of actual scupper opening.**

Scupper Size:  Height (A) x  Width (B) x  Length (C)

Downspout Size:  Width (D) x  Depth (E)

Choose a Color

Scupper Color: White  Gray  Dk.Gray  Tan

Skirt Color: White  Gray  Dk.Gray  Tan

Collector Color: \_\_\_\_\_

Quantity Required: \_\_\_\_\_

ADDITIONAL NOTES

THE MINIMUM SIZE OF THE COLLECTOR HEAD WILL BE DETERMINED BY THE DIMENSIONS GIVEN FOR THE SCUPPER (A & B) AND THE DOWNSPOUT (D & E), PLUS AN ADDITIONAL 3" ON EACH SIDE.

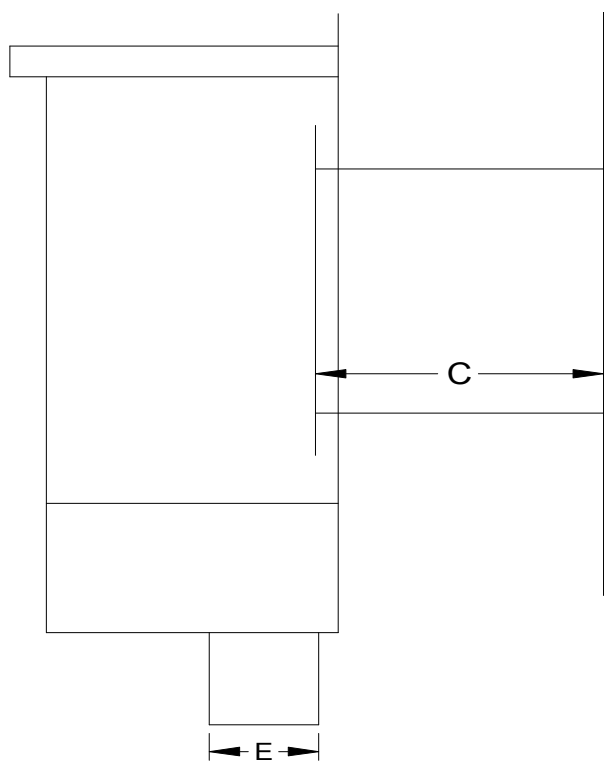
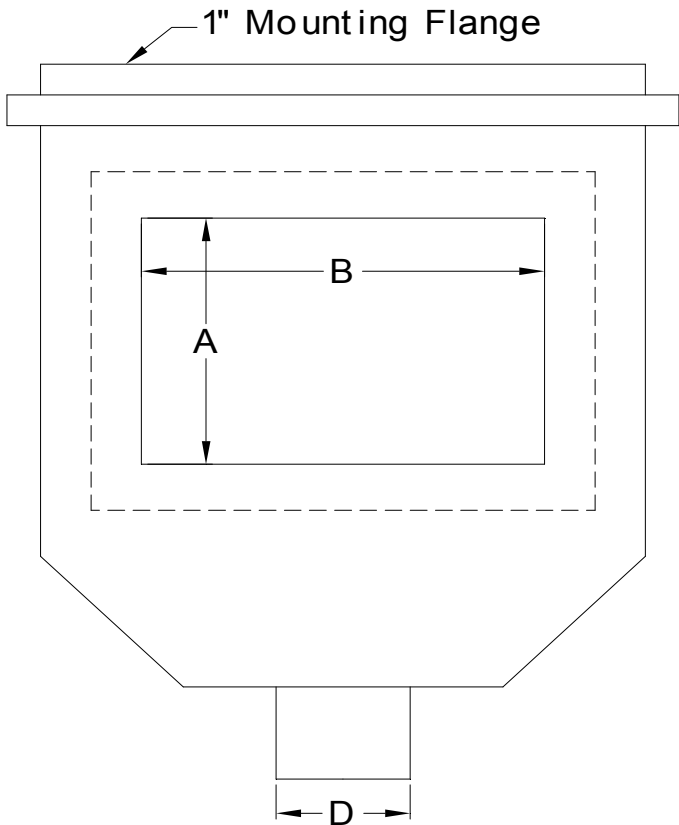

# GUTTERS & ACCESSORIES



525 Morley Drive  
Saginaw, MI 48601  
Ph: 1 (800) 248-0280  
Fx: 1 (800) 432-9331



831 Morley Drive  
Saginaw, MI 48601  
Ph: 1 (800) 248-0280  
Fx: 1 (989) 753-7073

Date: \_\_\_\_\_

Status:  Quote  Order

Ordered By: \_\_\_\_\_ Acct. # \_\_\_\_\_  
 Contractor: \_\_\_\_\_  
 Address: \_\_\_\_\_  
 City: \_\_\_\_\_ St: \_\_\_\_\_ Zip: \_\_\_\_\_  
 Phone #: \_\_\_\_\_ Fax: \_\_\_\_\_  
 Special Instructions: \_\_\_\_\_  
 \_\_\_\_\_  
 \_\_\_\_\_  
 \_\_\_\_\_

Job Name: \_\_\_\_\_  
 Address: \_\_\_\_\_  
 City: \_\_\_\_\_ St: \_\_\_\_\_ Zip: \_\_\_\_\_  
 P.O. #: \_\_\_\_\_ Job #: \_\_\_\_\_  
 Original Order #: \_\_\_\_\_  
 Membrane Thickness: \_\_\_\_\_  
 Ship Via: \_\_\_\_\_  
 Ship To:  Contractor Location  Jobsite  
 Other (provide address below)  
 \_\_\_\_\_

## "X" Styles (straps not installed)\* STANDARD 10'-0" LENGTHS

Gutter Style	Gutter Color: _____				
	Style	A	B	C	Linear ft.
	DX4	6	4	4	
	DX5	7	5	5	
	DX6	7	6	5	
	EX4	6	4	4	
	EX5	7	5	5	
	EX6	7	6	5	
	LX4	6	4	4	
	LX5	7	5	5	
	LX6	7	6	5	
	MX4	6	4	4	
	MX5	7	5	5	
	MX6	7	6	5	

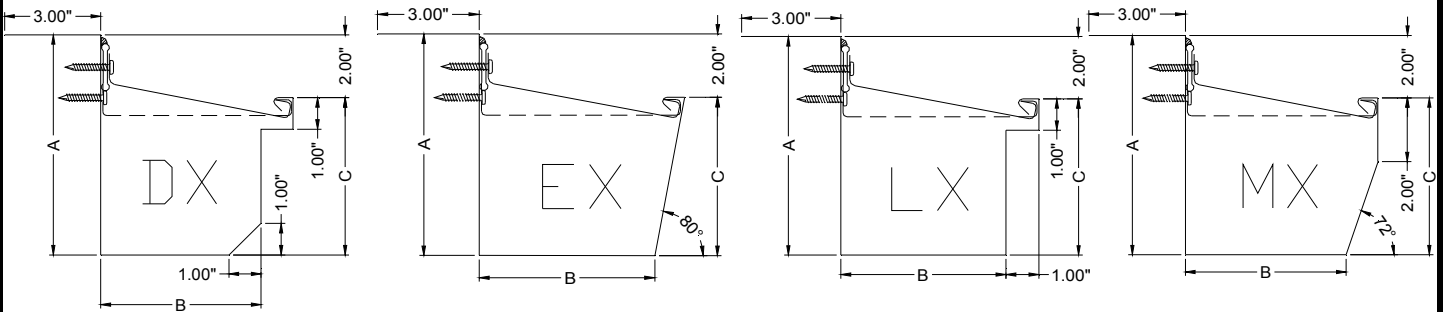

\* Straps can be factory installed at an additional cost.

CUSTOM LENGTHS	Quantity	Size needed:	
		Ea.	
		Ea.	
		Ea.	
		Ea.	
		Ea.	
		Ea.	
		Ea.	

GUTTER ACCESSORIES	Item	Quantity	Notes
	End Cap L		
	End Cap R		
	Splice Plate		
	I.C. Corner		
	O.C. Corner		
	Exp. Joint		
	Gutter Seal		
	Rivets (250)		
	Cust. Gutter		See Drawing

CUSTOM DRAWING

# DOWNSPOUTS & ACCESSORIES



525 Morley Drive  
Saginaw, MI 48601  
Ph: 1 (800) 248-0280  
Fx: 1 (800) 432-9331



831 Morley Drive  
Saginaw, MI 48601  
Ph: 1 (800) 248-0280  
Fx: 1 (989) 753-7073

Date: \_\_\_\_\_

Status:  Quote  Order

Ordered By: \_\_\_\_\_ Acct. # \_\_\_\_\_

Job Name: \_\_\_\_\_

Contractor: \_\_\_\_\_

Address: \_\_\_\_\_

Address: \_\_\_\_\_

City: \_\_\_\_\_ St: \_\_\_\_\_ Zip: \_\_\_\_\_

City: \_\_\_\_\_ St: \_\_\_\_\_ Zip: \_\_\_\_\_

P.O. #: \_\_\_\_\_ Job #: \_\_\_\_\_

Phone #: \_\_\_\_\_ Fax: \_\_\_\_\_

Original Order #: \_\_\_\_\_

Special Instructions: \_\_\_\_\_

Membrane Thickness: \_\_\_\_\_

Ship Via: \_\_\_\_\_

Ship To:  Contractor Location  Jobsite  
 Other (provide address below)

LARGE END

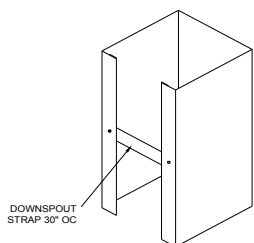
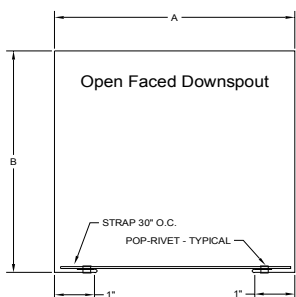
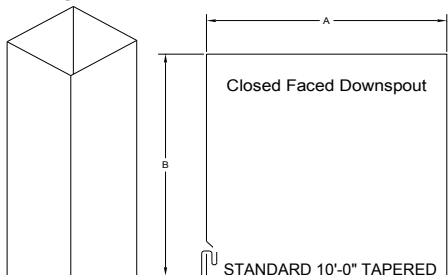

		FACE		NOTES/DESCRIPTION
		OPEN	CLOSED	
<b>ITEM</b>	<b>QUANTITY</b>			
DS-34 (3"x4"):	LF.			
DS-44 (4"x4"):	LF.			
DS-45 (4"x5"):	LF.			
DS-66 (6"x6"):	LF.			
Custom: "A X "B	LF.			
Square to Round	---			
"A X "B to "Ø	EA.			
Outlets / Drops:	EA.			
Elbows - 45° (Style A)	EA.			
Elbows - 80° (Style A)	EA.			
Elbows - 45° (Style B)	EA.			
Elbows - 80° (Style B)	EA.			
DS Straps (Ln. Ft.):	LF.			
10'-0" LENGTHS ONLY				
Gutter Sealant:	EA.			
Rivets (250/box):	EA.			

DOWNSPOUTS AND ACCESSORIES

**NOTES**

\_\_\_\_\_  
\_\_\_\_\_  
\_\_\_\_\_  
\_\_\_\_\_  
\_\_\_\_\_

SMALL END

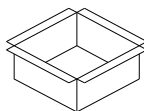

DROP/OUTLET

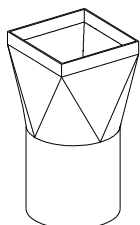

SQUARE END

SQUARE-TO-ROUND DRAIN ADAPTOR

ROUND END

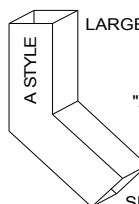

LARGE END

45 DEGREE "A" OR "B" ELBOW

SMALL END

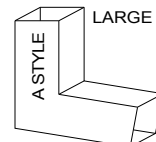

LARGE END

80 DEGREE "A" OR "B" ELBOW

SMALL END



# 2-PIECE SNAP-ON COMPRESSION & FASCIA BASE



525 Morley Drive  
Saginaw, MI 48601  
Ph: (800) 248-0280  
Fx: (800) 432-9331



831 Morley Drive  
Saginaw, MI 48601  
Ph: (800) 248-0280  
Fx: (989) 753-7073

Date: \_\_\_\_\_

Status:  Quote  Order

Ordered By: \_\_\_\_\_ Acct. #: \_\_\_\_\_  
Contractor: \_\_\_\_\_  
Address: \_\_\_\_\_  
City: \_\_\_\_\_ St: \_\_\_\_\_ Zip: \_\_\_\_\_  
Phone #: \_\_\_\_\_ Fax: \_\_\_\_\_  
Special Instructions: \_\_\_\_\_  
\_\_\_\_\_  
\_\_\_\_\_  
\_\_\_\_\_

Job Name: \_\_\_\_\_  
Address: \_\_\_\_\_  
City: \_\_\_\_\_ St: \_\_\_\_\_ Zip: \_\_\_\_\_  
P.O. #: \_\_\_\_\_ Job #: \_\_\_\_\_  
Original Order #: \_\_\_\_\_  
Membrane Thickness: \_\_\_\_\_  
Ship Via: \_\_\_\_\_  
Ship To:  Contractor Location  Jobsite  
 Other (provide address below)  
\_\_\_\_\_

2-PIECE SNAP-ON COMPRESSION			COLOR: _____	COVER PROFILE:
DESCRIPTION	SIZE	QTY.	COVER MATERIAL	<p>REGULAR FACE: <input type="checkbox"/></p> <p>FLAT FACE: <input type="checkbox"/></p>
3" - 8" 2-Piece Snap-On Base		FT.	24ga. Kynar 500	
3" - 8" 2-Piece Snap-On Cover		FT.	24ga. Galvalume Plus	
2-Piece Snap-On O.S. Corner		EA.	24ga. Bonderized	
2-Piece Snap-On I.S. Corner		EA.	.040 Alum. Mill. Finish	
<b>2-PIECE FLEX SNAP-ON COMPRESSION*</b>			.040 Alum. Kynar 500	
3" - 8" 2-Piece Flex Snap-On Base		FT.	24ga. Stainless steel	
3" - 8" 2-Piece Flex Snap-On Cover		FT.	16oz. Copper	
<b>* Flat Face Only</b>			Other ( specify below)	
<b>*NEW* 2-PIECE SNAP-ON COMPRESSION LG.*</b>				
9" - 13" 2-Piece Snap-On Base LG.		FT.		
9" - 13" 2-Piece Snap-On Cover LG.		FT.		
2-Piece Snap-On O.S. Corner LG.		EA.		
2-Piece Snap-On I.S. Corner LG.		EA.		
<b>* Cover is fabricated in .040 Aluminum</b>				
<b>* Base is fabricated in 22ga. Galvanized</b>				
<b>CUSTOM 2-PIECE SNAP-ON COMPRESSION</b>				
Custom 2-Piece Snap-On Cover		FT.		<b>Custom 2-Piece Sketch:</b> 
Custom 2-Piece Snap-On Base		FT.		
Custom 2-Piece O.S. Corner		EA.		
Custom 2-Piece I.S. Corner		EA.		
<b>SNAP-ON FASCIA BASE**</b>				
DESCRIPTION	QTY.	MATERIAL TYPE:		PROFILE:
4" Fascia Base	FT.	24ga. Galvalume Plus		<p>** Used with 2-Piece Snap-On Compression Cover</p>
5" Fascia Base	FT.	24ga. Stainless steel		
6" Fascia Base	FT.	Other ( specify below)		
7" Fascia Base	FT.			
8" Fascia Base	FT.			
<b>EDGE EXTENDER***</b>				
DESCRIPTION	SIZE	QTY.	MATERIAL TYPE	PROFILE:
Edge Extender (3" - 8")		FT.	24ga. Kynar 500	<p>Can be used with any edge detail, including gutter and coping.</p>
Cleat		FT.	24ga. Galvalume Plus	
<b>*** 4" and greater requires cleat</b>			24ga. Bonderized	
			.040 Alum. Mill. Finish	
			.040 Alum. Kynar 500	
			24ga. Stainless steel	
			16oz. Copper	
			Other ( specify below)	

# VINYL-COATED DRIP EDGE, T-EDGE, T-EDGE PLUS, & EDGE EXTENDER



525 Morley Drive  
Saginaw, MI 48601  
Ph: (800) 248-0280  
Fx: (800) 432-9331



831 Morley Drive  
Saginaw, MI 48601  
Ph: (800) 248-0280  
Fx: (989) 753-7073

Date: \_\_\_\_\_

Status:  Quote  Order

Ordered By: \_\_\_\_\_ Acct. #: \_\_\_\_\_  
 Contractor: \_\_\_\_\_  
 Address: \_\_\_\_\_  
 City: \_\_\_\_\_ St: \_\_\_\_\_ Zip: \_\_\_\_\_  
 Phone #: \_\_\_\_\_ Fax: \_\_\_\_\_  
 Special Instructions: \_\_\_\_\_

Job Name: \_\_\_\_\_  
 Address: \_\_\_\_\_  
 City: \_\_\_\_\_ St: \_\_\_\_\_ Zip: \_\_\_\_\_  
 P.O. #: \_\_\_\_\_ Job #: \_\_\_\_\_  
 Original Order #: \_\_\_\_\_  
 Membrane Thickness: \_\_\_\_\_  
 Ship Via: \_\_\_\_\_  
 Ship To:  Contractor Location  Jobsite  
 Other (provide address below)

## VINYL-COATED DRIP EDGE W/SKIRT

DESCRIPTION	SIZE	QTY. FT.
Vinyl-Coated Drip Edge (2" - 6")*		
Cleat (3-1/2" standard)		
Custom Vinyl-Coated Drip Edge		
<b>*4" and greater requires cleat</b>		
<b>FACE COLOR:</b>		<b>SKIRT COLOR:</b>
White		White
Tan		Tan
Gray		Gray
Dark Gray		Dark Gray

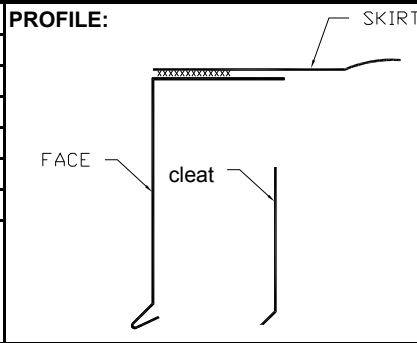

**Custom Vinyl-Coated Drip Edge Sketch:**

## T-EDGE

DESCRIPTION	SIZE	QTY. FT.
T-Edge (2" - 6")*		
Cleat (3-1/2" standard)		
Custom T-Edge		
<b>* 4" and greater requires cleat</b>		
<b>FACE COLOR:</b> _____		

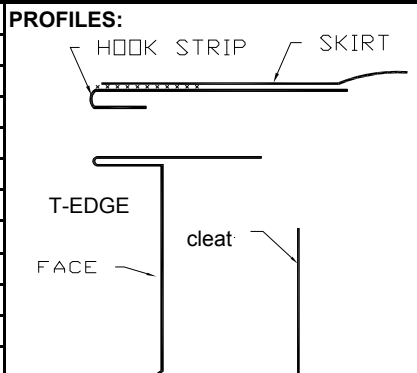

**Custom T-Edge Sketch:**

## T-EDGE PLUS

DESCRIPTION	SIZE	QTY. FT.
T-Edge Plus (2" - 6")*		
Cleat (3-1/2" standard)		
Custom T-Edge Plus		
<b>* 4" and greater requires cleat</b>		
<b>MATERIAL TYPE:</b>		<b>SKIRT COLOR:</b>
24ga. Kynar 500		White
24ga. Galvalume Plus		Tan
24ga. Bonderized		Gray
.040 Alum. Mill. Finish		Dark Gray
.040 Alum. Kynar 500		<b>HOOK STRIP:</b>
24ga. Stainless steel		White
Other ( specify below)		Tan
		Gray
		Dark Gray

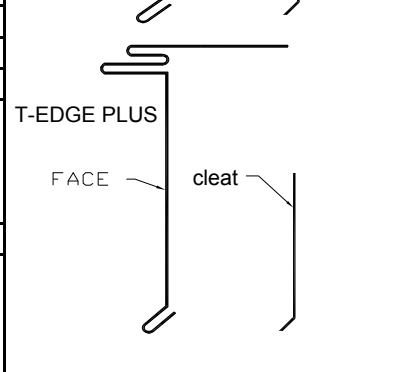

**Custom T-Edge Plus Sketch:**

## EDGE EXTENDER\*

DESCRIPTION	SIZE	QTY. FT.
Edge Extender (3" - 8")		
Cleat		
<b>* 4" and greater requires cleat</b>		

**COLOR:** \_\_\_\_\_

MATERIAL TYPE
24ga. Kynar 500
24ga. Galvalume Plus
24ga. Bonderized
.040 Alum. Mill. Finish
.040 Alum. Kynar 500
24ga. Stainless steel
16oz. Copper
Other ( specify below)

**PROFILE:**

Can be used with any edge detail, including gutter and coping.

## FASCIA COVER & EDGE EXTENDER



525 Morley Drive  
Saginaw, MI 48601  
Ph: (800) 248-0280  
Fx: (800) 432-9331



831 Morley Drive  
Saginaw, MI 48601  
Ph: (800) 248-0280  
Fx: (989) 753-7073

Date: \_\_\_\_\_

Status:  Quote  Order

Ordered By: \_\_\_\_\_ Acct. #: \_\_\_\_\_

Job Name: \_\_\_\_\_

Contractor: \_\_\_\_\_

Address: \_\_\_\_\_

Address: \_\_\_\_\_

City: \_\_\_\_\_ St: \_\_\_\_\_ Zip: \_\_\_\_\_

City: \_\_\_\_\_ St: \_\_\_\_\_ Zip: \_\_\_\_\_

P.O. #: \_\_\_\_\_ Job #: \_\_\_\_\_

Phone #: \_\_\_\_\_ Fax: \_\_\_\_\_

Original Order #: \_\_\_\_\_

Special Instructions: \_\_\_\_\_

Membrane Thickness: \_\_\_\_\_

Ship Via: \_\_\_\_\_

Ship To:  Contractor Location  Jobsite

Other (provide address below)

1-3/4" FASCIA COVER			COLOR: _____	COVER PROFILE:	
DESCRIPTION	QTY.	COVER MATERIAL			
1-3/4" Fascia Cover	FT.	24ga. Kynar 500	<input type="checkbox"/>	<input type="checkbox"/>	
1-3/4" Fascia Cover O.S. Corner	EA.	24ga. Galvalume Plus	<input type="checkbox"/>	<input type="checkbox"/>	
1-3/4" Fascia Cover I.S. Corner	EA.	24ga. Bonderized	<input type="checkbox"/>	<input type="checkbox"/>	
Notes:		.040 Alum. Mill. Finish	<input type="checkbox"/>	<input type="checkbox"/>	
		.040 Alum. Kynar 500	<input type="checkbox"/>	<input type="checkbox"/>	
		24ga. Stainless steel	<input type="checkbox"/>	<input type="checkbox"/>	
		16oz. Copper	<input type="checkbox"/>	<input type="checkbox"/>	
		Other ( specify below)	<input type="checkbox"/>	<input type="checkbox"/>	
4" FASCIA COVER			COLOR: _____	COVER PROFILE:	
DESCRIPTION	QTY.	COVER MATERIAL			
4" Fascia Cover	FT.	24ga. Kynar 500	<input type="checkbox"/>	<input type="checkbox"/>	
4" Fascia Cover O.S. Corner	EA.	24ga. Galvalume Plus	<input type="checkbox"/>	<input type="checkbox"/>	
4" Fascia Cover I.S. Corner	EA.	24ga. Bonderized	<input type="checkbox"/>	<input type="checkbox"/>	
Notes:		.040 Alum. Mill. Finish	<input type="checkbox"/>	<input type="checkbox"/>	
		.040 Alum. Kynar 500	<input type="checkbox"/>	<input type="checkbox"/>	
		24ga. Stainless steel	<input type="checkbox"/>	<input type="checkbox"/>	
		16oz. Copper	<input type="checkbox"/>	<input type="checkbox"/>	
		Other ( specify below)	<input type="checkbox"/>	<input type="checkbox"/>	
4" FLEX FASCIA COVER			COLOR: _____	COVER PROFILE:	
DESCRIPTION	QTY.	COVER MATERIAL			
4" Flex Fascia Cover	FT.	24ga. Kynar 500	<input type="checkbox"/>	<input type="checkbox"/>	
Notes:		24ga. Galvalume Plus	<input type="checkbox"/>	<input type="checkbox"/>	
		24ga. Bonderized	<input type="checkbox"/>	<input type="checkbox"/>	
		.040 Alum. Mill. Finish	<input type="checkbox"/>	<input type="checkbox"/>	
		.040 Alum. Kynar 500	<input type="checkbox"/>	<input type="checkbox"/>	
		24ga. Stainless steel	<input type="checkbox"/>	<input type="checkbox"/>	
		16oz. Copper	<input type="checkbox"/>	<input type="checkbox"/>	
		Other ( specify below)	<input type="checkbox"/>	<input type="checkbox"/>	
EDGE EXTENDER*			COLOR: _____	PROFILE:	
DESCRIPTION	SIZE	QTY.	COVER MATERIAL		
Edge Extender (3" - 8")		FT.	24ga. Kynar 500	<input type="checkbox"/>	
Cleat		FT.	24ga. Galvalume Plus	<input type="checkbox"/>	
* 4" and greater requires cleat			24ga. Bonderized	<input type="checkbox"/>	
			.040 Alum. Mill. Finish	<input type="checkbox"/>	
			.040 Alum. Kynar 500	<input type="checkbox"/>	
			24ga. Stainless steel	<input type="checkbox"/>	
			16oz. Copper	<input type="checkbox"/>	
			Other ( specify below)	<input type="checkbox"/>	
Can be used with any edge detail, including gutter and coping.					

# GRAVEL STOP COVER & EDGE EXTENDER



525 Morley Drive  
Saginaw, MI 48601  
Ph: (800) 248-0280  
Fx: (800) 432-9331



831 Morley Drive  
Saginaw, MI 48601  
Ph: (800) 248-0280  
Fx: (989) 753-7073

Date: \_\_\_\_\_

Status:  Quote  Order

Ordered By: \_\_\_\_\_ Acct. #: \_\_\_\_\_

Job Name: \_\_\_\_\_

Contractor: \_\_\_\_\_

Address: \_\_\_\_\_

Address: \_\_\_\_\_

City: \_\_\_\_\_ St: \_\_\_\_\_ Zip: \_\_\_\_\_

City: \_\_\_\_\_ St: \_\_\_\_\_ Zip: \_\_\_\_\_

P.O. #: \_\_\_\_\_ Job #: \_\_\_\_\_

Phone #: \_\_\_\_\_ Fax: \_\_\_\_\_

Original Order #: \_\_\_\_\_

Special Instructions: \_\_\_\_\_

Membrane Thickness: \_\_\_\_\_

Ship Via: \_\_\_\_\_

Ship To:  Contractor Location  Jobsite

Other (provide address below)

## 2" GRAVEL STOP COVER

COLOR: \_\_\_\_\_

COVER PROFILE:

DESCRIPTION	QTY.	COVER MATERIAL
2" Gravel Stop Cover	FT.	24ga. Kynar 500
2" Gravel Stop Cover O.S. Corner	EA.	24ga. Galvalume Plus
2" Gravel Stop Cover I.S. Corner	EA.	24ga. Bonderized
<b>Notes:</b>		.040 Alum. Mill. Finish
		.040 Alum. Kynar 500
		24ga. Stainless steel
		16oz. Copper
		Other ( specify below)

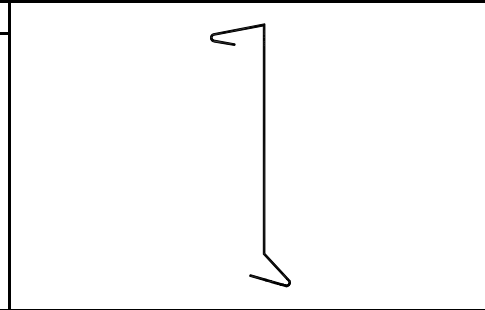

## 4" GRAVEL STOP COVER

COLOR: \_\_\_\_\_

COVER PROFILE:

DESCRIPTION	QTY.	COVER MATERIAL
4" Gravel Stop Cover	FT.	24ga. Kynar 500
4" Gravel Stop Cover O.S. Corner	EA.	24ga. Galvalume Plus
4" Gravel Stop Cover I.S. Corner	EA.	24ga. Bonderized
<b>Notes:</b>		.040 Alum. Mill. Finish
		.040 Alum. Kynar 500
		24ga. Stainless steel
		16oz. Copper
		Other ( specify below)

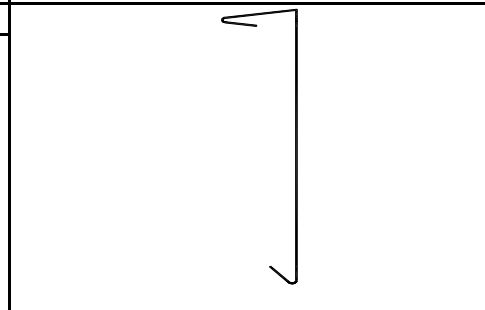

## EDGE EXTENDER\*

COLOR: \_\_\_\_\_

PROFILE:

DESCRIPTION	SIZE	QTY. FT.	COVER MATERIAL
Edge Extender (3" - 8")			24ga. Kynar 500
Cleat			24ga. Galvalume Plus
<b>* 4" and greater requires cleat</b>			24ga. Bonderized
<b>Notes:</b>			.040 Alum. Mill. Finish
			.040 Alum. Kynar 500
			24ga. Stainless steel
			16oz. Copper
			Other ( specify below)

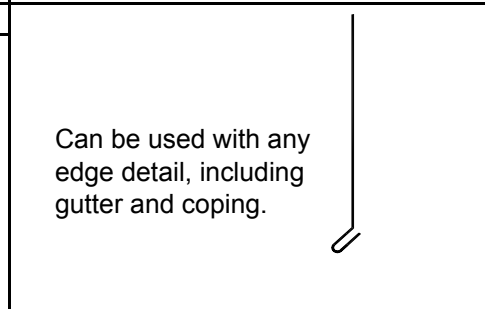





# CUSTOM METAL



525 Morley Drive  
Saginaw, MI 48601  
Ph: (800) 248-0280  
Fx: (800) 432-9331



831 Morley Drive  
Saginaw, MI 48601  
Ph: (800) 248-0280  
Fx: (989) 753-7073

Date: \_\_\_\_\_

Status:  Quote  Order

Ordered By: \_\_\_\_\_ Acct. #: \_\_\_\_\_

Job Name: \_\_\_\_\_

Contractor: \_\_\_\_\_

Address: \_\_\_\_\_

Address: \_\_\_\_\_

City: \_\_\_\_\_ St: \_\_\_\_\_ Zip: \_\_\_\_\_

City: \_\_\_\_\_ St: \_\_\_\_\_ Zip: \_\_\_\_\_

P.O. #: \_\_\_\_\_ Job #: \_\_\_\_\_

Phone #: \_\_\_\_\_ Fax: \_\_\_\_\_

Original Order #: \_\_\_\_\_

Special Instructions: \_\_\_\_\_

Membrane Thickness: \_\_\_\_\_

\_\_\_\_\_

Ship Via: \_\_\_\_\_

\_\_\_\_\_

Ship To:  Contractor Location  Jobsite

\_\_\_\_\_

Other (provide address below)

\_\_\_\_\_

## CUSTOM METAL SKETCH

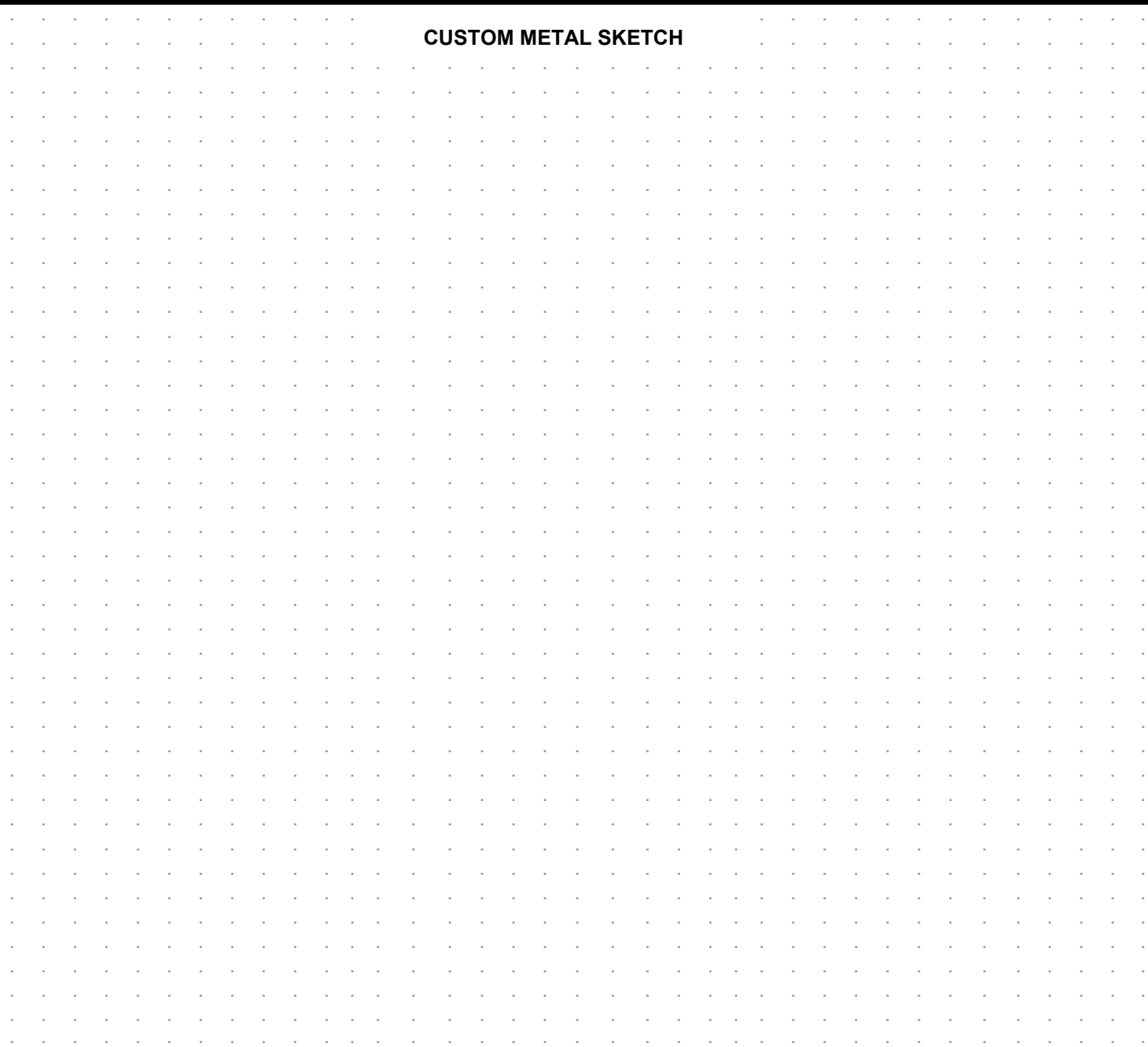

# ARCHED DRIP EDGE & ARCHED COPING



525 Morley Drive  
Saginaw, MI 48601  
Ph: (800) 248-0280  
Fx: (800) 432-9331



831 Morley Drive  
Saginaw, MI 48601  
Ph: (800) 248-0280  
Fx: (989) 753-7073

Date: \_\_\_\_\_

Status:  Quote  Order

Ordered By: \_\_\_\_\_ Acct. # \_\_\_\_\_  
 Contractor: \_\_\_\_\_  
 Address: \_\_\_\_\_  
 City: \_\_\_\_\_ St: \_\_\_\_\_ Zip \_\_\_\_\_  
 Phone #: \_\_\_\_\_ Fax: \_\_\_\_\_  
 Special Instructions: \_\_\_\_\_  
 \_\_\_\_\_  
 \_\_\_\_\_

Job Name: \_\_\_\_\_  
 Address: \_\_\_\_\_  
 City: \_\_\_\_\_ St \_\_\_\_\_ Zip \_\_\_\_\_  
 P.O. #: \_\_\_\_\_ Ship Via: \_\_\_\_\_  
 Original Order # : \_\_\_\_\_  
 Ship To:  Contractor Location  Jobsite  
 Other (provide address below)  
 \_\_\_\_\_

Provide radius (A.) when possible along with the following measurements:

- Total arch length is required. (B.) **Fig. 1.1**
- When possible measure the entire width of the arch (cord length). If the entire cord length cannot be measured specify the cord length used. (C.) **Fig. 1.1**
- H or height. (D.) **Fig. 1.1**

Note: When the entire width of the arch is not measured verify the height measurement in several locations using the same cord length.

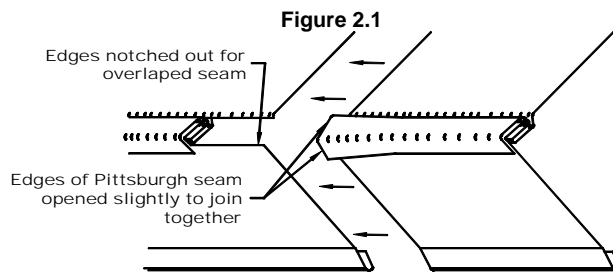
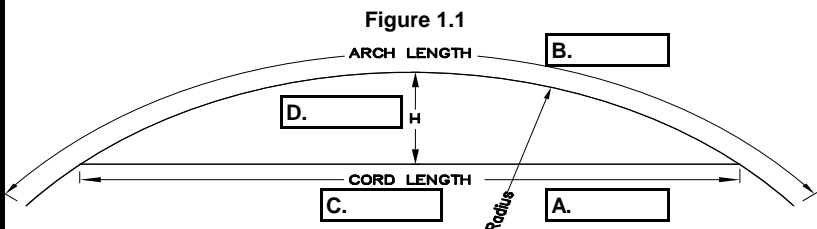

The ends of each arched piece are pre-notched to fit together in the field. **Fig. 2.1**

**Fabrication will proceed only after receipt of the signed approval package that will be sent to you.**

## ARCHED DRIP EDGE:

Available face sizes of 2-6" \*

Splice Cleat

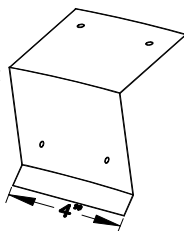

### Roof flange (vinyl coated) :

White   
 Tan   
 Gray   
 Dark gray

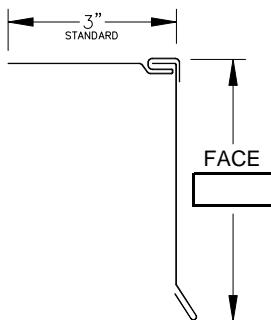

### Face material type:

24ga. Kynar 500   
 .032 Aluminum   
 24ga. Bonderized

Face color: \_\_\_\_\_

\* 4" or larger face size require splice cleats 24" o.c.

\*This edge detail has not been tested to ES-1 standards and may not be compliant with certain specifications.

## ARCHED COPING:

Available face and back sizes of 2-6" \*

Provide - Face (A.), Top (B.), Back (C.)

Splice Cleat

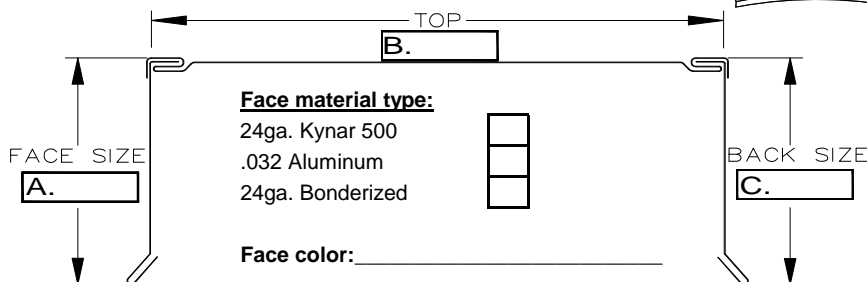
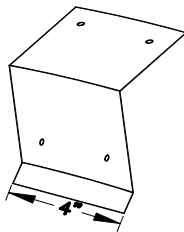

### Face material type:

24ga. Kynar 500   
 .032 Aluminum   
 24ga. Bonderized

Face color: \_\_\_\_\_

\* 4" or larger face size require splice cleats 24" o.c.

\*This edge detail has not been tested to ES-1 standards and may not be compliant with certain specifications.